

# CIS

**3G-SDI/HD-SDI  
FULL HD CMOS High Sensitivity Color Camera**

# **VCC-HD1000A**

## **Product Specifications & Operational Manual**

**CIS Corporation**

## Table of Contents

1.	Precautions.....	1
1.1.	Handling Precautions.....	1
1.2.	Restrictions on Applications.....	1
1.3.	Disclaimers (Exception Clause) .....	1
2.	Product Outline.....	2
2.1.	Features.....	2
2.2.	Accessories.....	2
3.	Specifications.....	3
3.1.	General Specifications .....	3
3.2.	Part Names and Functions .....	5
4.	Camera Functions.....	7
4.1.	GenLock.....	7
4.2.	LTC (Longitudinal Time Code) .....	7
4.3.	Defective Pixel Correction .....	8
4.3.1	Defective Pixel Data Type .....	8
4.3.2	Notes for Defective Pixel Correction .....	8
5.	Serial Communication .....	9
5.1.	Serial Communication Settings .....	9
5.1.1	Changing Speed of Serial Communication .....	10
5.2.	Command List.....	11
5.3.	Quick Reference Table .....	20
5.3.1	Quick Reference Table for Gain Settings .....	20
5.3.2	Quick Reference Table for Shutter Settings .....	21
6.	How to Operate Camera with OSD Function.....	22
6.1.	How to Control OSD Menu by Remote Controller.....	22
6.2.	Indication of OSD Menu.....	22
6.3.	OSD Menu Hierarchical Structure .....	22
7.	Dimensions.....	24
8.	Case for Indemnity (Limited Warranty).....	25
8.1.	Product Warranty .....	25
8.2.	CMOS Defective Pixels .....	25
8.3.	Product Support.....	25

## 1. Precautions

### 1.1. Handling Precautions

- Do not use or store camera in dusty or humid places.
- Do not apply excessive force or static electricity that could damage camera. Handle camera with care.
- Do not shoot direct images that are extremely bright (e.g., light source, sun, etc.). When extremely strong light source is shot, smear or blooming may occur. When camera is not in use, please put the lens cap on.
- Follow the instructions in [Chapter 3.2. "Part Names and Functions"](#) for connecting camera. Improper connection may cause damages not only to the camera but also to the connected devices.
- Confirm mutual ground potential carefully and connect camera to monitors or computers. AC leak from the connected devices may cause damages or destroy the camera.
- Do not apply excessive voltage. (Use only the specified voltage.) Unstable or improper power supply voltage may cause damages or malfunction of the camera.
- Since VCC-HD1000A is a compact and dense camera, camera temperature rises. Please take appropriate heat dissipation measures, such as installing the camera to a metal plate etc.
- Our warranty does not apply to damages or defects caused by irregular and/or abnormal use of the product.

Our warranty does not apply to damages or malfunctions caused by neglecting instructions and precautions explained in this manual.

### 1.2. Restrictions on Applications

- The camera must not be used for any nuclear equipment or aerospace equipment with which mechanical failure or malfunction could result in serious bodily injury or loss of human life.
- The camera must not be used under conditions or environments other than those specified in this manual.

### 1.3. Disclaimers (Exception Clause)

CIS should not be liable for any damages or losses if;

- damages or losses are caused by earthquake, lightning strike, fire, flood, or other acts of God.
- damages or losses are caused by deliberate or accidental misuse by user, or failure to observe information and instructions explained in this manual.
- damages or losses are caused by repair or modification conducted by user or any unauthorized party.

## 2. Product Outline

VCC-HD1000A is a Full HD color camera with 0.0005 lx super sensitivity. Using a 35mm full size CMOS image sensor, the maximum frame rate achieves 60fps. 3G-SDI interface and features CIS proprietary ISP, "Clairvu™" image processing engine for superb imaging quality and high speed processing. Complies with BT.2020 (Wide color gamut) and BT2100 (Hybrid Log-Gamma). Suitable for wide variety of applications such as ITS, security, medical imaging systems, and life science systems.

### 2.1. Features

- Features CIS proprietary ISP, state-of-the-art "Clairvu™" for superb imaging quality.
- Infrared-level of high sensitivity (0.0005 lx, F1.2)
- GenLock function (Black burst or 3-values SYNC signals)
- Supports RS-232C control and RS-422 control.
- LTC (Longitudinal Time code)
- Supports OSD (On Screen Display) function with an optional remote controller, RU-100.

### 2.2. Accessories

- Standard accessory
  - ◆ Lens cap
- Optional accessories
  - ◆ RS-232C remote controller: RU-100
- Free software

※ CIS control software is available for evaluation purpose only.

CIS should be held harmless for any damage arising from the use of this control software.

The purpose of this control software is restricted to evaluation and testing of this product only, and is not intended for commercial use by customer.

CIS will not customize the program nor provide the source code.

## 3. Specifications

## 3.1. General Specifications

Electrical Specifications		
Image sensor	Sensor type	35mm full size color CMOS sensor
	Effective pixels	2160(H) × 1280(V)
	Unit cell size	19μm(H) × 19μm(V)
Resolution	1080p, 1080i: 720p:	1920(H) × 1080(V) 1280(H) × 720(V)
Aspect ratio	16 : 9	
Video output format	1920 x 1080p @60fps (Level A) 3G-SDI 1920 x 1080p @60fps (Level B) 3G-SDI 1920 x 1080p @59.94fps (Level A) 3G-SDI 1920 x 1080p @59.94fps (Level B) 3G-SDI 1920 x 1080p @50fps (Level A) 3G-SDI 1920 x 1080p @50fps (Level B) 3G-SDI 1920 x 1080i @60fps HD-SDI 1920 x 1080i @59.94fps HD-SDI 1920 x 1080i @50fps HD-SDI 1920 x 1080p @30fps HD-SDI 1920 x 1080p @29.97fps HD-SDI 1920 x 1080p @25fps HD-SDI 1920 x 1080p @24fps HD-SDI 1920 x 1080p @23.98fps HD-SDI 1280 x 720p @60fps HD-SDI 1280 x 720p @59.94fps HD-SDI 1280 x 720p @50fps HD-SDI	
Sync. system	Internal sync. / External sync.	
Video output standard	3G-SDI/HD-SDI: Y/Pb/Pr(4:2:2 10bit) BNC 75Ω termination	
Sensitivity	F13 2000 lx	
Minimum illumination	F1.2 0.0005 lx Conditions: VIDEO 50%, AGC +78dB, theoretical value when electric shutter setting is 1/30s.	
Gain variable range	AGC (Max. gain: 0dB ~ +78dB) MANUAL: 0dB ~ +78dB	
Shutter speed	MANUAL: 1/11200s ~ 1s AUTO: 1/11200s ~ 1s	
White balance	MANUAL, AUTO, Preset MANUAL: Red Gain, Blue Gain, One Push AUTO: Standard/Outdoor/Fluorescent Preset: Custom(Color temperature settings)/Tungsten(3200K)/Daylight(5500K)/Cloudy(6500K)/Shade(8000K)	
Auto exposure detection	Average/Center-Weight/Spot(per 1/256)/Backlight Compensation	
Flicker cancellation	ON, OFF(typ.)	
Edge enhancement	OFF, 1~7(typ.2)	
Color correction	Auto, Standard, Fluorescent Light, Tungsten Lamp	
Chroma adjustment	0%(B/W) ~ 100%(typ.) ~ 200%	
Color saturation suppression	OFF, 1~7(typ.5)	
Noise reduction	OFF, 1~6	
Gamma correction	ITU-R BT.709, BT.2100(HLG)	

Color gamut	Complies with ITU-R BT.709 and BT.2020	
Master pedestal	-100 ~ 0 ~ +100	
Pedestal (R,G,B)	RGB independent, -100 ~ 0(typ.) ~ +100	
Color balance	RGB independent, 0 ~ 100(typ.) ~ 200	
Defective pixel (white points) correction	Corrected upon shipment.	
LTC	OFF, ON Accepts external SMPTE Time code in the LTC IN terminal. (Supports resetting internal time code.)	
Camera preset settings	1, 2, 3, and 4 (Four kinds of preset to store.)	
Remote communications	Supports RS-232C signals via $\phi$ 3.5 (4 poles), and RS-422 signals via 12pins connector to control camera settings. Supports camera settings on OSD (On Screen Display) with the optional remote controller, RU-100, and camera settings from PC with control software.	
Power requirements	DC+11 ~ +17V	
Power consumption (typ.)	12.6W with DC+12V IN	
<b>Mechanical Specifications</b>		
Dimensions	H: 75mm W: 75mm D: 85mm excluding projection. Please refer to <a href="#">Section 7. Dimensions</a> for details.	
Weight	Approx. 650g	
Lens mount	EF mount Please refer to <a href="#">Section 7. Dimensions</a> for details.	
<b>Environmental Specifications</b>		
Safety/Quality standards	UL: Conform to UL Standard including materials. FCC: CFR 47 part15 subpart B Class A Digital Device This device complies with Part 15 of the FCC Rules. Operation is subject to the following two conditions: (1) this device may not cause harmful interference, and (2) this device must accept any interference received, including interference that may cause undesired operation. CE: EMC: 2014/30/EU Emission: EN61000-6-4:2007+A1:2011 Immunity: EN61000-6-2:2005 RoHS: 2011/65/EU + (EU)2015/863 EN50581 (RoHS2)	
Durability	Vibration	Acceleration: 98m/s <sup>2</sup> (10G)
		Frequency: 20 ~ 200Hz
		Direction: X, Y, and Z 3 directions
		Testing time: 120min each
	Shock	No malfunction with 980m/s <sup>2</sup> (100G) for $\pm$ X, $\pm$ Y, and $\pm$ Z, in 6 directions (without packaging).
Operational temperature	-5 ~ +45°C Humidity: 20 ~ 80%RH with no condensation.	
Storage temperature	-25 ~ +60°C Humidity: 20 ~ 80%RH with no condensation.	

[3G-SDI output Level A and Level B]

The difference between Level A and Level B is a way of mapping Y signal and Cb/Cr signal onto 3G-SDI standard signal. The difference does not affect the resolution of the video signal.

Some 3G-SDI receivers correspond to either Level A or B, whereas other receivers correspond to both Levels, so please set the camera mode to match your 3G-SDI receiver.

3.2. Part Names and Functions

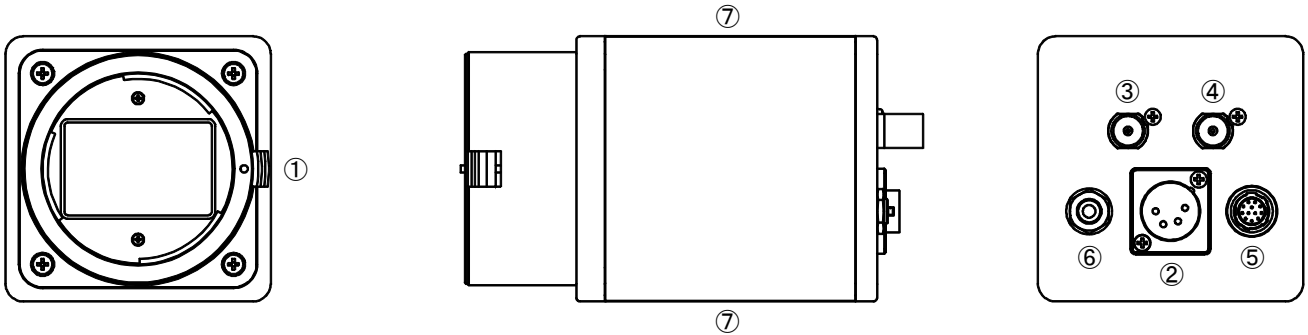

① EF mount

There is no electric contact. Please use a lens that you can operate manually.

② 4pin XLR connector (For power input)

Supply power via XLR cable.

Please use XLR4-11C (female plug) or equivalent for cable side.

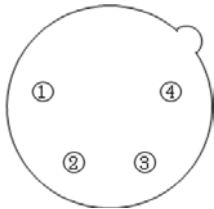

Pin No.	Signals
1	GND
2	N.C.
3	N.C.
4	EXT DC +12V

③ BNC connector (For video signal output)

With BNC cable, connect to a 3G-SDI input monitor or HD-SDI input monitor.

Use high-frequency BNC cable that comply with 3G-SDI or HD-SDI.

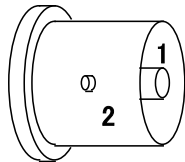

Pin No.	Signals
1	3G-SDI/HD-SDI output
2	GND

④ BNC connector (For GENLOCK signal input)

Input analog external sync signals (black burst or 3-values SYNC) via BNC cable.

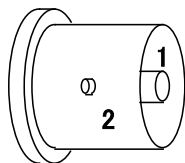

Pin No.	Signals
1	Analog external sync. signal input
2	GND

- ⑤ 12pins circular connector (For RS-422 communication)  
Please use HR10-10P-12S (73) or equivalent for cable side.



Pin No.	Signals
1	GND
2	EXT_422_RX-
3	EXT_422_RX+
4	EXT_422_TX-
5	EXT_422_TX+
6	N.C.
7	LTC_IN
8	N.C.
9	Test terminal (Do not connect.)
10	Test terminal (Do not connect.)
11	Test terminal (Do not connect.)
12	GND

- ⑥  $\phi$ 3.5 (4 poles) connector (For RS-232C communication)  
Do not connect any audio equipment such as earphones to avoid failure and malfunction.

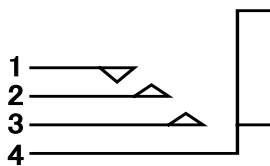

Pin No.	Signals
1	Power(+5V) *Optional
2	TXD(Camera)
3	RXD(Camera)
4	GND

Connection of  $\phi$ 3.5 (4 poles) connector (For RS-232C communication)

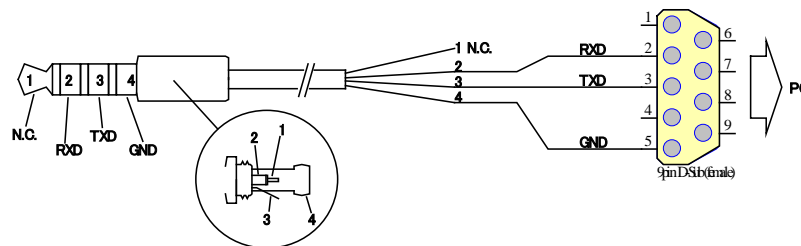

- ⑦ Screw holes for camera installation (Six positions in total)  
Front and rear: UNC1/4 Depth 5.5  
Center: UNC3/8 Depth 5.5  
Please refer to [Section 7. Dimensions](#) for details on the screw hole positions.  
Please note that screws longer than 5.5mm may damage the internal PCB.



#### 4. Camera Functions

##### 4.1. GenLock

GenLock function is available by inputting analog external sync signals (black burst or 3-values SYNC) into the BNC terminal for GenLock. Corresponding external sync signals vary depending on camera output format. Please refer to the chart below for details.

		EXT SYNC IN				
CAMERA FORMAT	1080p60A			1080i60	720p60	1080p30
	1080p59.9A	NTSC		1080i59.9	720p59.9	1080p29.9
	1080p50A		PAL	1080i50	720p50	1080p25
	1080p60B			1080i60	720p60	1080p30
	1080p59.9B	NTSC		1080i59.9	720p59.9	1080p29.9
	1080p50B		PAL	1080i50	720p50	1080p25
	1080i60			1080i60	720p60	1080p30
	1080i59.94	NTSC		1080i59.9	720p59.9	1080p29.9
	1080i50		PAL	1080i50	720p50	1080p25
	1080p30			1080i60	720p60	1080p30
	1080p29.9	NTSC		1080i59.9	720p59.9	1080p29.9
	1080p25		PAL	1080i50	720p50	1080p25
	1080p24					1080p24
	1080p23					1080p23.9
	720p60			1080i60	720p60	1080p30
	720p59.9	NTSC		1080i59.9	720p59.9	1080p29.9
	720p50		PAL	1080i50	720p50	1080p25

[Note]

- Input Black Burst signals for NTSC/PAL signal. Input 3-values SYNC signals for other than NTSC/PAL signal.
- Terminate EXT SYNC IN with 75Ω. (It becomes high impedance when turning off camera power).
- When an external signal specified above is input, the camera will automatically be in external sync. mode.
- When there is no external signal input, the camera will operate in internal sync. mode.
- Disturbance images occur immediately after inputting external signals. However, this is normal.
- Disturbance images may occur or there will be no image when inputting signals other than those specified in the above chart to the EXT SYNC IN terminal.

##### 4.2. LTC (Longitudinal Time Code)

- Supports time code insertion to 3G/HD SDI signals.
- Input LTC signals (time code) to the LTC IN terminal of the 12pins connector to insert external time code. When there is no signal input to the LTC IN terminal, user can insert internal time code. Internal time code starts with 00:00:00.00 when power is ON, and when signals are input to the LTC IN terminal, time code switches to external time code. Under this condition, if no signal is input to the LTC IN terminal, internal time code starts.

Signal format: SMPTE Time code

Signal level: 0.5~2 [Vp-p]

### 4.3. Defective Pixel Correction

In addition to the correction of defective pixel data registered upon shipment, we provide a method to update the defective pixel data. The maximum number to register is 128 points. Please refer to [Section 5.2. Command List](#) for details.

#### 4.3.1 Defective Pixel Data Type

There are two types of defective pixel data.

- Defective data registered at factory  
Data registered upon shipment from our factory. These data cannot be over-written.
- Defective data registered by user  
Data registered by user.

#### 4.3.2 Notes for Defective Pixel Correction

- To save the data registered or deleted with defective pixel correction command (SU 200~203), execute SAVE command (SU 705).
- Init command (SU 700) does not restore defective pixel correction data. Use SU 203 to delete all data.
- Defective pixel correction data is not subject to Camera Setting Store/Load command (SU 100/101).
- Factory data and user-register data cannot be the same. Therefore, if user detects the same defective points, this function ignores those points.
- If user specifies the same coordinates as factory setting data, error will occur.
- Specify coordinates with standard 1920×1080 regardless of video format settings.
- Please note that the detected results may not always be the same due to temperature, noise, and other conditions.

Neglecting these instructions may cause not only incorrect pixel defect correction, but also failure of acquiring proper images.

## 5. Serial Communication

## 5.1. Serial Communication Settings

(1) Please refer to the chart below for serial communication settings.

I/F	RS-232C or RS-422
Baud rate	9600bps (factory setting), 38400bps, 115200bps
Data	8bit
Stop bit	1bit
Parity	None
XON/XOFF	Not controlled

RS-232C and RS-422 are mutually exclusive.

(2) Control code

- Text-based communication executes camera control. Only ASCII 0x20–0x7E, 0x0A (LF=¥n), and 0x0D (CR=¥r) must be used. Please do not use other than these codes.
- By sending command, parameter, and CR(0x0D) from host to camera, you can change camera settings and acquire camera-setting parameters. Either CR or LF can be a linefeed code.
- There are two types of commands. One is SU command to send settings and instructions to the camera (“S” for “Set”), and the other is GU command (“G” for “Get”) to obtain information from the camera.

Command	Parameter 1	Parameter 2	Function
GU	Address	Normally None (There are exceptions in some cases)	To obtain camera setting information.
SU	Address	Data (There may be more than one)	To change camera settings.

(3) How to input a command

- “>” must be output from the camera as a prompt.
- Commands are not case-sensitive.
- Separate between a command and a parameter by single space (0x20).
- From the head of the input character to the linefeed code (CR) is defined as a single serial command.
- Parameters start with 0x are regarded as hexadecimal, parameters start with 0b are regarded as binary, and others are regarded as decimal.
- Commands analyze parameters from the head to identifiable letters.
- Please refer to [Section 5.2 “Command List”](#) for details on address and data.
- Do not input values and letters other than those explained in the above and those mentioned in [Section 5.2 “Command List”](#).
- Camera receives the returned command from Host and echo the command back. At this time, camera converts the linefeed code (CR) to CR LF and echo the code back.

(4) Setting examples

[Example of GU command]

To get information of address 10

[Send] GU[sp]10[¥r]

[Returned value] GU[sp]10[¥r][¥n]

[Returned value] 50[¥r] [¥n]

[Returned value] [¥r] [¥n]

[Returned value] >[sp]

[Echo back]

[Acquired data + Linefeed]

[Linefeed]

[Prompt (> and space)]

[¥r]=CR(0x0D)

[¥n]=LF(0x0A)

[sp]=Space(0x20)

[Example of SU command]

To set 30 to address 10

[Send] SU[sp]10[sp]30[¥r]

[Returned value] SU[sp]10[sp]30[¥r][¥n] [Echo back]

[Returned value] [¥r] [¥n] [Linefeed]

[Returned value] >[sp] [Prompt (> and space)]

### 5.1.1 Changing Speed of Serial Communication

Baud rate command (SU 725) changes transfer rate of serial communication out of 9600bps, 38400bps, and 115200bps.

- The changes made are reflected after re-booting camera, not immediately after executing the command.
- Execute SAVE command (SU 705) to save the setting values.
- Baud rate command is not subject to Init command (SU 700) so that executing Init command does not restore settings.
- Baud rate command is not subject to Camera Setting Store/Load command (SU 100/101).
- Only when baud rate setting is 9600bps, user can use the optional remote controller RU-100.
- Transfer rate of serial communication for RS-232C and RS-422 must be the same.

## 5.2. Command List

Video Format				
Function	Address	Setting value	Initial value	Description
Video Format	1	0: 1080p 60fps (Level A) 1: 1080p 59.94fps (Level A) 2: 1080p 50fps (Level A) 3: 1080p 60fps (Level B) 4: 1080p 59.94fps (Level B) 5: 1080p 50fps (Level B) 6: 1080i 60fps 7: 1080i 59.94fps 8: 1080i 50fps 9: 1080p 30fps 10: 1080p 29.97fps 11: 1080p 25fps 12: 1080p 24fps 13: 1080p 23.98fps 14: 720p 60fps 15: 720p 59.94fps 16: 720p 50fps	4	This is to set video output format.

AE Related				
Function	Address	Setting value	Initial value	Description
Gain Mode	2	0: Manual 1: Auto	1	This is to set gain control mode.
Gain Value	3	Magnification×0x10000 (0x10000~0x20000000)	0x10000 (65536)	This is to set gain value when gain mode is Manual. (1*) 1.0 magnification(0[dB]): 0x00010000 ※Please refer to Section <a href="#">5.3.1 Quick Reference Table</a> .
Gain Max. Value	4	Magnification×0x10000 (0x10000~0x20000000)	0x20000000	This is to set the maximum gain value when gain mode is Auto. (1*) 1.0 magnification(0[dB]): 0x00010000
Shutter Mode	5	0: Manual 1: Auto	1	This is to set shutter control mode.
Shutter Value	6	Exposure time [sec]×0x100000 (0x5E~0x100000)	0x4444 (17476) 1/60s	This is to set shutter value when shutter mode is Manual. With longer shutter value than frame rate, mode becomes slow shutter operation. (1*) ※Please refer to <a href="#">Section 5.3.2 Quick Reference Table</a> .
Shutter Limit	7	The 1 <sup>st</sup> param: Max. value Exposure time [sec]×0x100000 (0x5E~0x100000)	0x4444 (17476) 1/60s	This is to set shutter limit when shutter mode is Auto. With longer shutter value than frame rate, mode becomes slow shutter operation. (1*) Ex.) To set Max=1/60s, Min=1/8000s. SU 7 0x4444 0x83 ※ Max < Min is invalid. ※Please refer to <a href="#">Section 5.3.2 Quick Reference Table</a> .
		The 2 <sup>nd</sup> param: Min. value Exposure time [sec]×0x100000 (0x5E~0x100000)	0x5E (94) 1/11200s	
Metering Mode	8	0: Average 1: Center-weighted 2: Spot 3: Backlight compensation	1	This is to set metering mode.
Spot Block	9	The 1 <sup>st</sup> param: X value: 0~15	7	This is to set X, Y, W, and H value for spot metering. X: Far left of metering field Block, X coordinate Y: Top of metering field Block, Y coordinate W: Width of metering field (number of block) H: Height of metering field (number of block) Ex.) SU 9 7 7 2 2
		The 2 <sup>nd</sup> param: Y value: 0~15	7	
		The 3 <sup>rd</sup> param: W value: 1~16	2	
		The 4 <sup>th</sup> param: H value: 1~16	2	
AE Speed	10	0~15	10	This is to set AE convergence speed.
Exposure Compensation Value	11	0(-12dB)~12(0dB)~24 (+12dB)/per 1dB	12	This is to set exposure compensation value.
Flicker Cancel	12	0: Off 1: On	0	This is to set ON/OFF of flicker cancel. Valid only when video format is 60fps, 59.94fps, 30fps, and 29.97fps.

Gain Value, Plus Minus	13	-1: decrease 1dB 1 : increase 1dB	None	This is to change gain value by $\pm 1$ dB from the current setting. Valid when gain mode is Manual. (Dedicated to SU.)
Shutter Speed, Plus Minus	14	-1: decrease 1step (1/4EV) 1 : increase 1step (1/4EV)	None	This is to change shutter speed by $\pm 1$ step (1/4EV) from the current value. When shutter speed decreases by 1step, shutter value becomes bigger. (*1) Valid when shutter mode is Manual. (Dedicated to SU)
Current Gain	55	None	None	This is to acquire the current gain. (Dedicated to GU.) (*1)
Current Shutter	56	None	None	This is to acquire the current shutter value. (Dedicated to GU.) (*1)

(\*1) Due to physical limitation of the sensor and circuit, there are some cases that user cannot control values and limits of gain and shutter as designated by commands. User can check the actual values with Current Gain and Current Shutter commands. AE may become unstable with high gain settings (0 x4000000 and over). If you wish to use camera with slow shutter operation, set gain to 0x4000000 and under.

WB Related				
Function	Address	Setting value	Initial value	Description
WB Mode	20	0: Manual 1: Auto 2: Preset	1	This is to set white balance mode (WB).
WB Manual Memory	21	0~4	0	This is to choose the memory to store set values when WB Mode is Manual. (*2)
Manual Red Gain	22	100~1600(%)	185	This is to set Red gain when WB mode is Manual.
Manual Blue Gain	23	100~1600(%)	163	This is to set Blue gain when WB mode is Manual.
One Push Trigger	24	1: WxH 2: W/2 x H/2 3: W/4 x H/4	None	This is to execute One Push WB when WB mode is Manual. (*3) Choose a detection range with setting values. (Dedicated to SU)
WB Auto Func	25	0: Standard 1: Outdoor 2: Fluorescent	0	This is to choose the condition when WB Mode is Auto.
WB Preset Func	26	0: Custom 1: Tungsten (3200K) 2: Daylight (5500K) 3: Cloudy (6500K) 4: Shade (8000K)	2	This is to choose the environmental lighting condition when WB Mode is Preset.
WB Preset Temp	27	2500~15000(K)	5500	This is to set color temperature when WB Preset Func is Custom.
WB LB Shift	28	-10~10	0	This is to set the shifting amount of WB gain toward black.
WB CC Shift	29	-10~10	0	This is to set the shifting amount of WB gain toward green magenta.
Current Red Gain	58	None	None	This is to acquire the current Red Gain. (Dedicated to GU)
Current Blue Gain	59	None	None	This is to acquire the current Blue Gain. (Dedicated to GU)

(\*2) Memory stores up to five types of settings (0 ~ 4).

(\*3) Do not shield light to execute this command.

If execution of One Push WB is not properly processed, camera will return Runtime Error.



Image Quality Related				
Function	Address	Setting value	Initial value	Description
Detail	30	0: Off 1: (Low)~7(High)	2	This is to set the strength of edge enhancement.
Gamma	35	0: BT.709 -2 1: BT.709 -1 2: BT.709 3: BT.709 +1 4: BT.709 +2 5: HLG75	2	This is to set gamma type and contrast. 0~4 are the curves comply with BT.709. Contrast changes in the range of -2 ~ +2. 5 is for HLG75 that means 75% output level is regarded as 100% input level.
Knee	36	0: Off 1: 100% 2: 95% 3: 90% 4: 85% 5: 80% 6: 75%	4	This is to set knee point. Valid except when Gamma is BT.709 and D-range is Low. Knee slope varies according to the selected maximum D-Range.
Master Pedestal	37	-100~+100	0	This is to set Master pedestal.
Red Pedestal	38	-100~+100	0	This is to set Red pedestal.
Green Pedestal	39	-100~+100	0	This is to set Green pedestal.
Blue Pedestal	40	-100~+100	0	This is to set Blue pedestal.
Red Balance	41	0~200	100	This is to set Red balance.
Green Balance	42	0~200	100	This is to set Green balance.
Blue Balance	43	0~200	100	This is to set Blue balance.
D-Range	44	0: Low Equivalent to 120% for BT.709 Invalid for HLG (Handled as Normal)  1: Normal Equivalent to 200% for BT.709 Equivalent to 600% for HLG  2: High Equivalent to 400% for BT.709 Equivalent to 1200% for HLG  3: Very High Equivalent to 600% for BT.709 Invalid for HLG (Handled as High)	1	This is to set Dynamic range. Normal or High are selectable with HLG. Low is regarded as Normal, and Very High is regarded as High. When Low, both D range and sensitivity decrease, but noise level becomes the lowest. The minimum gain value will be limited to 0x20000 with High, and it will be limited to 0x30000 with Very High. (Even if a lower value is set, gain value becomes 0x20000 or 0x30000.)  ※ The D-range definition of BT.709 and HLG are different, ref. below.  [BT.709] 100% output level (without Knee) is regarded as 100% input level. [HLG] 50% output level is regarded as 100% input level.
Color Saturation	45	0~200	100	This is to set color saturation.

Noise Reduction	50	0: Off 1: (Low)~6(High)	3	This is to set the level of noise reduction. (*4)
Color Correction	52	0: Auto 1: Standard 2: Fluorescent light 3: Tungsten lamp	0	This is to set color correction.
Color Suppression	53	0: Off 1: (Low)~7(High)	5	This is to set color suppression.
Color Space	54	0: BT.709 1: BT.2020	0	This is to set color gamut.

(\*4) When intensity increase, residual images may become evident.

OSD Related				
Function	Address	Setting value	Initial value	Description
OSD Up button	90	0: One push 1: Continuous push	None	Commands to operate OSD.  Send commands every 60msec for continuous push. (Dedicated to SU).
OSD Down button	91	0: One push 1: Continuous push	None	
OSD Right button	92	0: One push 1: Continuous push	None	
OSD Left button	93	0: One push 1: Continuous push	None	
OSD Center button	94	0: One push 1: Continuous push	None	
Text Color	95	0: Black 1: Blue 2: Red 3: Magenta 4: Green 5: Cyan 6: Yellow 7: White	7	This is to set the text color of OSD menu.
Highlight Color	96	0: Black 1: Blue 2: Red 3: Magenta 4: Green 5: Cyan 6: Yellow 7: White	5	This is to set the selected letter's font color of OSD menu.  If user specifies the same color as the text color, error will occur because the selected letters cannot be recognized.
OSD Off	99	1 (Fixed)	None	This is to close OSD menu. (Dedicated to SU)

Others				
Function	Address	Setting value	Initial value	Description
Camera Setting Store	100	0~3	0	User can store four kinds of camera settings. Execute SAVE (SU 705 1) to save the registered values into the non-volatile memory. The registered data and address to store (the set value of this address) are not subject to Init command (SU 700 0).
Camera Setting Load	101	0~3		This is to read out and reflect the registered values set by Camera Setting Store to camera. Selection of address to store and address to load are common so that this command keeps the last set value with Store or Load. (GU 100 and GU 101 always return the same value).
LTC Mode	103	0: Off 1: On	0	This is to set OFF/ON of LTC signals insertion.
LTC Reset	104	1: Reset	None	This is to reset the timer for internal self-run of LTC. (Dedicated to SU)
GenLock V Offset	106	-1024~1023	0	Adjustment of V phase when mode is external sync. Supports adjustment per 1H.
GenLock H Offset	107	-2047~2047	0	Adjustment of H phase when mode is external sync. Supports adjustment per approx. 6.7ns. ※ There may be ±40ns differences between the set value and the actual value because of power restoration or changes of format.
Test Pattern	120	0: Off 1: Cross Line	0	This is to set test pattern indication.
Cross Line Position	121	The 1st Param: X coordinate 0~1919	960	This is to set the address of the crossing point.
		The 2nd Param: Y coordinate 0~1079	540	
Init	700	0 (Fixed)	None	This is to restore camera settings to factory settings. Camera store-data, address to store, defective pixel correction data, and baud rate are not subject to this command. (Dedicated to SU)
Save	705	1 (Fixed)	None	This is to save camera settings. After storing the current camera settings by Store (Equivalent to SU100), this command saves the stored data, the address to store, defective pixel correction data, and baud rate. (Dedicated to SU)

Version Information	721	1: Micro-computer version 2: FPGA version	None	This is to acquire version information. (Dedicated to GU)
Baud Rate	725	9600, 38400, 115200 (bps)	9600	This is to set the speed of serial communication. Please refer to <a href="#">Section 5.1.1 "Changing Speed of Serial Communication"</a> for details.
SDI Compatibility Mode	750	0: Off 1: On	0	With factory setting (Off), if user selects HLG75 or BT.2020, changes made will be reflected to SDI Payload ID. With SDI compatibility mode ON however, changes made are not subject to reflect. Set this mode ON if you are using a receiving equipment, which outputs no image with HLG75 or BT.2020.

Defective Pixel Correction			
Function	Address	Setting value	Description
Defective pixel detection	200	The 1 <sup>st</sup> Parameter: Threshold (0~4095)	This is to detect defective pixels (white defect) and register them as user register data. Defective pixels are output value, which exceeds the threshold level. Execute this command with light shielded and set appropriate gain and shutter values.
		The 2 <sup>nd</sup> Parameter: 0=New registration 1=Additional registration	
Defective pixel registration	201	The 1 <sup>st</sup> Parameter: X coordinate (0~1919)	This is to register defective pixels as user register data by specifying their coordinates.
		The 2 <sup>nd</sup> Parameter: Y coordinate (0~1079)	
Defective pixel deletion	202	The 1 <sup>st</sup> Parameter: X coordinate (0~1919)	This is to delete defective pixels from user register data by specifying their coordinates. (Dedicated to SU)
		The 2 <sup>nd</sup> Parameter: Y coordinate (0~1079)	
Deletion of defective pixel correction data	203	1: Entire deletion	This is to delete all user register data. (Dedicated to SU).
Indication of defective pixel correction data	204	1: Indicate the coordinates and their attributes of all defective pixels. 2: Indicate the coordinates and their attributes of user register data. 3: Indicate the total number of all registered defective pixels per region. 4: Indicate the number of user register data per region.	This is to indicate information on the registered defective pixel correction data. (Dedicated to GU).

- When user specifies "new registration" with defective pixel detection command, the command deletes only user register data by defective pixel detection. The command does not delete data registered by defective pixel registration command.
- The command classifies the registered defective pixels into four types. Attribute [W] and [B] are for data registered at factory, attribute [U] is data registered by user with defective pixels detection command, and attribute [P] is data registered by user with defective pixels registration command.
- [GU 200] command shows the number of pixels classified under [U] attribute, and [GU 201] command shows the number of pixels classified under [P] attribute.
- User can change only user register data, and cannot remove the factory setting data.
- User cannot register the pixels already been registered as factory data.

## 5.3. Quick Reference Table

## 5.3.1 Quick Reference Table for Gain Settings

dB	Magnification	Gain Value (=Magnification×0x10000)	
		(Dec)	(Hex)
0	1.000	65536	10000
1	1.122	73533	11F3D
2	1.259	82505	14249
3	1.413	92572	1699C
4	1.585	103868	195BC
5	1.778	116541	1C73D
6	1.995	130762	1FECA
7	2.239	146717	23D1D
8	2.512	164619	2830B
9	2.818	184706	2D182
10	3.162	207243	3298B
11	3.548	232531	38C53
12	3.981	260904	3FB28
13	4.467	292739	47783
14	5.012	328458	5030A
15	5.623	368536	59F98
16	6.310	413504	64F40
17	7.079	463959	71457
18	7.943	520571	7F17B
19	8.913	584090	8E99A
20	10.000	655360	A0000
21	11.220	735326	B385E
22	12.589	825049	C96D9
23	14.125	925721	E2019
24	15.849	1038676	FD954
25	17.783	1165413	11C865
26	19.953	1307615	13F3DF
27	22.387	1467168	166320
28	25.119	1646190	191E6E
29	28.184	1847055	1C2F0F
30	31.623	2072430	1F9F6E
31	35.481	2325305	237B39
32	39.811	2609035	27CF8B
33	44.668	2927386	2CAB1A
34	50.119	3284581	321E65
35	56.234	3685360	383BF0
36	63.096	4135042	3F1882
37	70.795	4639593	46CB69
38	79.433	5205710	4F6ECE
39	89.125	5840902	592006

dB	Magnification	Gain Value (=Magnification×0x10000)	
		(Dec)	(Hex)
40	100.000	6553600	640000
41	112.202	7353260	7033AC
42	125.893	8250494	7DE47E
43	141.254	9257206	8D40F6
44	158.489	10386756	9E7D44
45	177.828	11654132	B1D3F4
46	199.526	13076151	C786B7
47	223.872	14671683	DFDF43
48	251.189	16461899	FB304B
49	281.838	18470554	119D69A
50	316.228	20724303	13C3A4F
51	354.813	23253050	162D03A
52	398.107	26090352	18E1B70
53	446.684	29273856	1BEAF00
54	501.187	32845807	1F52FEF
55	562.341	36853601	2325761
56	630.957	41350421	276F515
57	707.946	46395935	2C3F21F
58	794.328	52057095	31A5407
59	891.251	58409021	37B403D
60	1000.000	65536000	3E80000
61	1122.018	73532601	46204B9
62	1258.925	82504936	4EAECE8
63	1412.538	92572061	584899D
64	1584.893	103867560	630E4A8
65	1778.279	116541319	6F24787
66	1995.262	130761511	7CB4327
67	2238.721	146716829	8BEB89D
68	2511.886	164618989	9CFE2ED
69	2818.383	184705544	B026208
70	3162.278	207243029	C5A4715
71	3548.134	232530503	DDC2247
72	3981.072	260903515	F8D125B
73	4466.836	292738559	1172D5FF
74	5011.872	328458065	1393DF51
75	5623.413	368536011	15F769CB
76	6309.573	413504205	18A592CD
77	7079.458	463959349	1BA77535
78	7943.282	520570952	1F074848

## 5.3.2 Quick Reference Table for Shutter Settings

Exposure time		Shutter Value (=sec×0x100000)	
(sec)	(us)	(Dec)	(Hex)
1/1	1000000.00	1048576	100000
1/2	500000.00	524288	80000
1/3	333333.33	349525	55555
1/4	250000.00	262144	40000
1/5	200000.00	209715	33333
1/6	166666.67	174763	2AAAB
1/7	142857.14	149797	24925
1/8	125000.00	131072	20000
1/9	111111.11	116508	1C71C
1/11	90909.09	95325	1745D
1/13	76923.08	80660	13B14
1/15	66666.67	69905	11111
1/18	55555.56	58254	E38E
1/21	47619.05	49932	C30C
1/25	40000.00	41943	A3D7
1/30	33333.33	34953	8889
1/36	27777.78	29127	71C7
1/42	23809.52	24966	6186
1/50	20000.00	20972	51EC
1/60	16666.67	17476	4444
1/75	13333.33	13981	369D
1/90	11111.11	11651	2D83
1/100	10000.00	10486	28F6
1/105	9523.81	9986	2702
1/120	8333.33	8738	2222
1/125	8000.00	8389	20C5
1/150	6666.67	6991	1B4F
1/180	5555.56	5825	16C1
1/210	4761.90	4993	1381
1/250	4000.00	4194	1062

Exposure time		Shutter Value (=sec×0x100000)	
(sec)	(us)	(Dec)	(Hex)
1/300	3333.33	3495	DA7
1/350	2857.14	2996	BB4
1/420	2380.95	2497	9C1
1/500	2000.00	2097	831
1/600	1666.67	1748	6D4
1/700	1428.57	1498	5DA
1/840	1190.48	1248	4E0
1/1000	1000.00	1049	419
1/1200	833.33	874	36A
1/1400	714.29	749	2ED
1/1700	588.24	617	269
1/2000	500.00	524	20C
1/2400	416.67	437	1B5
1/2800	357.14	374	176
1/3400	294.12	308	134
1/4000	250.00	262	106
1/4800	208.33	218	DA
1/5600	178.57	187	BB
1/6800	147.06	154	9A
1/8000	125.00	131	83
1/9600	104.17	109	6D
1/11200	89.29	94	5E

## 6. How to Operate Camera with OSD Function

In addition to operation by serial communication explained earlier, you can operate camera with OSD menu on a monitor screen by connecting an optional remote controller (RU-100).

### 6.1. How to Control OSD Menu by Remote Controller

[CENTER]	To indicate OSD top menu on your monitor screen when OSD menu does not appear. Also, use this button to choose the selected menu.
[▲]	Move up.
[▼]	Move down.
[◀]	Change options.
[▶]	Change options.

### 6.2. Indication of OSD Menu

- Menu with ▼ at the line end indicates that there are submenus to open with [CENTER] button.
- Menu with ◀ at the line end indicates that there is an upper hierarchical menu to return with [CENTER] button.
- Menu with ▶ at the line head indicates that [CENTER] button can execute command for the chosen item. Other menus execute commands every time user changes selection with [◀] and [▶].
- Please note that only representative values are selectable for gain and shutter with OSD menu. If you wish to set specific values, please use serial command setting.
- Some hidden items are mode-dependent. For example, when gain mode is Auto, menu does not indicate gain value.

### 6.3. OSD Menu Hierarchical Structure

The hierarchical structure of the OSD menu is as below. (Exclusion; Items to move hierarchies.)

```

├ Output Format
│   └ Video Format
├ Gain/Shutter
│   ├── Gain Mode
│   ├── Gain Value
│   ├── Gain Max Value
│   ├── Shutter Mode
│   ├── Shutter Value
│   ├── Shutter Limit
│   ├── AE Speed
│   ├── Exp Comp Value
│   ├── Metering Mode
│   ├── Spot Block
│   └ Flicker Cancel
├ White Balance
│   ├── WB Mode
│   ├── Auto Func
│   ├── Preset Func
│   ├── Preset Temp
│   ├── Manual Memory
│   ├── Manual Red Gain
│   ├── Manual Blue Gain
│   ├── One Push WB
│   └ LB Shift

```



- |   └ CC Shift
- └ Image Control
  - |   └ Red Balance
  - |   └ Green Balance
  - |   └ Blue Balance
  - |   └ Master Pedestal
  - |   └ Red Pedestal
  - |   └ Green Pedestal
  - |   └ Blue Pedestal
  - |   └ Detail
  - |   └ Gamma
  - |   └ Knee
  - |   └ D-Range
  - |   └ Noise Reduction
  - |   └ Color Correction
  - |   └ Color Saturation
  - |   └ Color Suppression
  - |   └ Color Space
  - |   └ SDI Compatibility
- └ LTC
  - |   └ LTC Mode
  - |   └ LTC Reset
- └ GenLock
  - |   └ V Offset
  - |   └ H Offset
- └ Test Pattern
  - |   └ Test Pattern
  - |   └ Position X
  - |   └ Position Y
- └ OSD Color
  - |   └ OSD Color (Text/Highlight)
  - |   └ Default
- └ Save/Load/Init
  - |   └ Save Settings
  - |   └ Load Settings
  - |   └ Init Settings

7. Dimensions

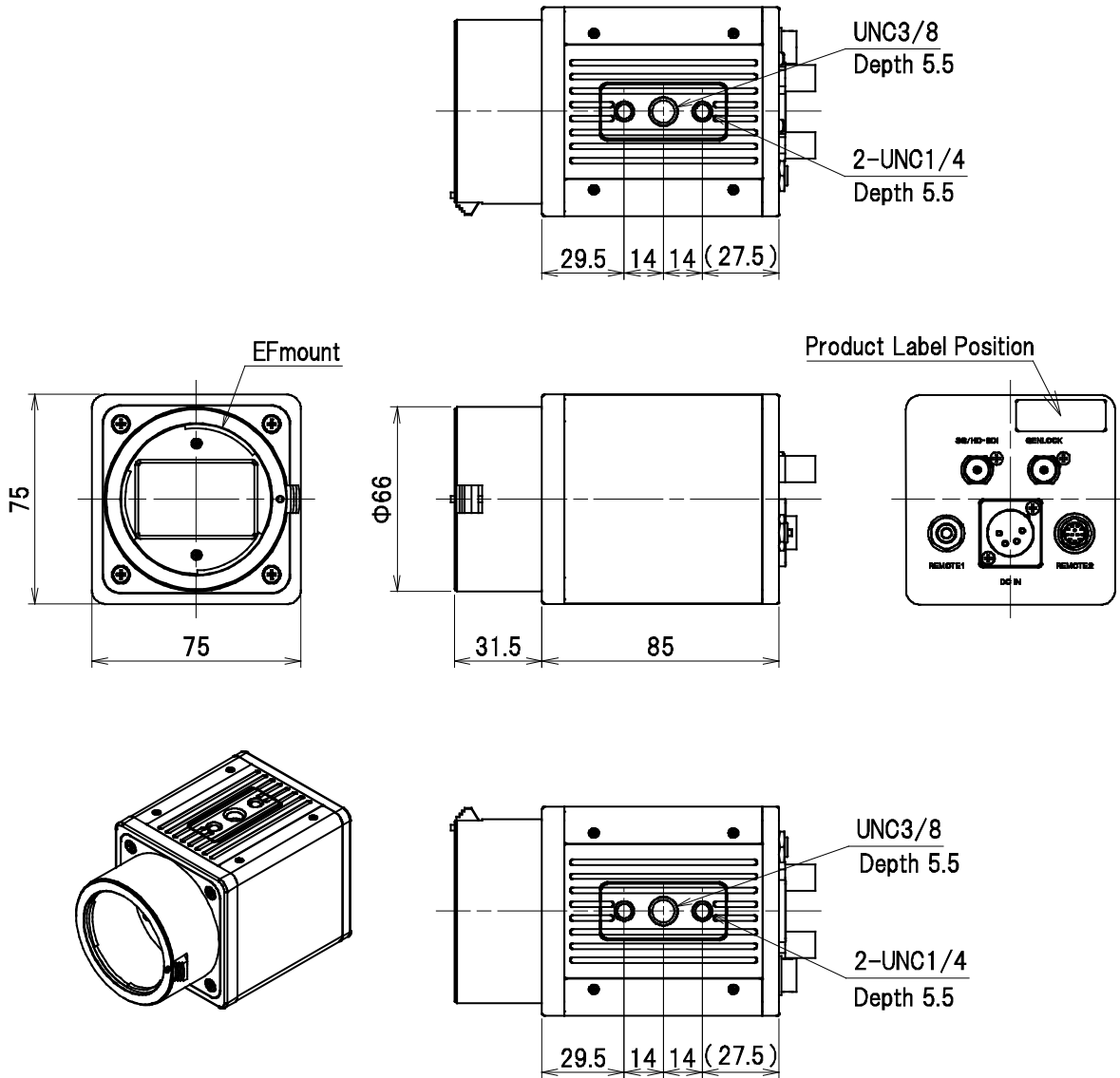

935-0141-00  
(Unit : mm)

## 8. Case for Indemnity (Limited Warranty)

### 8.1. Product Warranty

The term of warranty of this product is within 1.5 years from the date of shipping out from our factory. If you use the product properly and discover a defect during the warranty period, and if that was caused by designing or manufacturing, CIS Corporation, at its option, repairs or replaces it at no charge to you. Products out of warranty period will be subject to charge.

CIS should not hold responsible for damages or losses if;

- damages or losses are caused by earthquake, lightning strike, fire, flood or other acts of God.
- damages or losses are caused by deliberate or accidental misuse by user, or failure to observe information contained in the instructions in this Product Specification and Operational Manual.
- damages or losses are caused by repair or modification conducted by customer or any unauthorized party.

### 8.2. CMOS Defective Pixels

CIS applies defective pixel correction prior to the shipment of the product. However, the number of defective pixels are subject to increase due primarily to the effect of cosmic rays. Due to this nature, CIS should not hold responsible for the natural increase of defective pixels.

### 8.3. Product Support

Should you have any problems in function of the product you purchased, and if you need our further analysis and/or repair, please contact your local distributor.